

500 Series

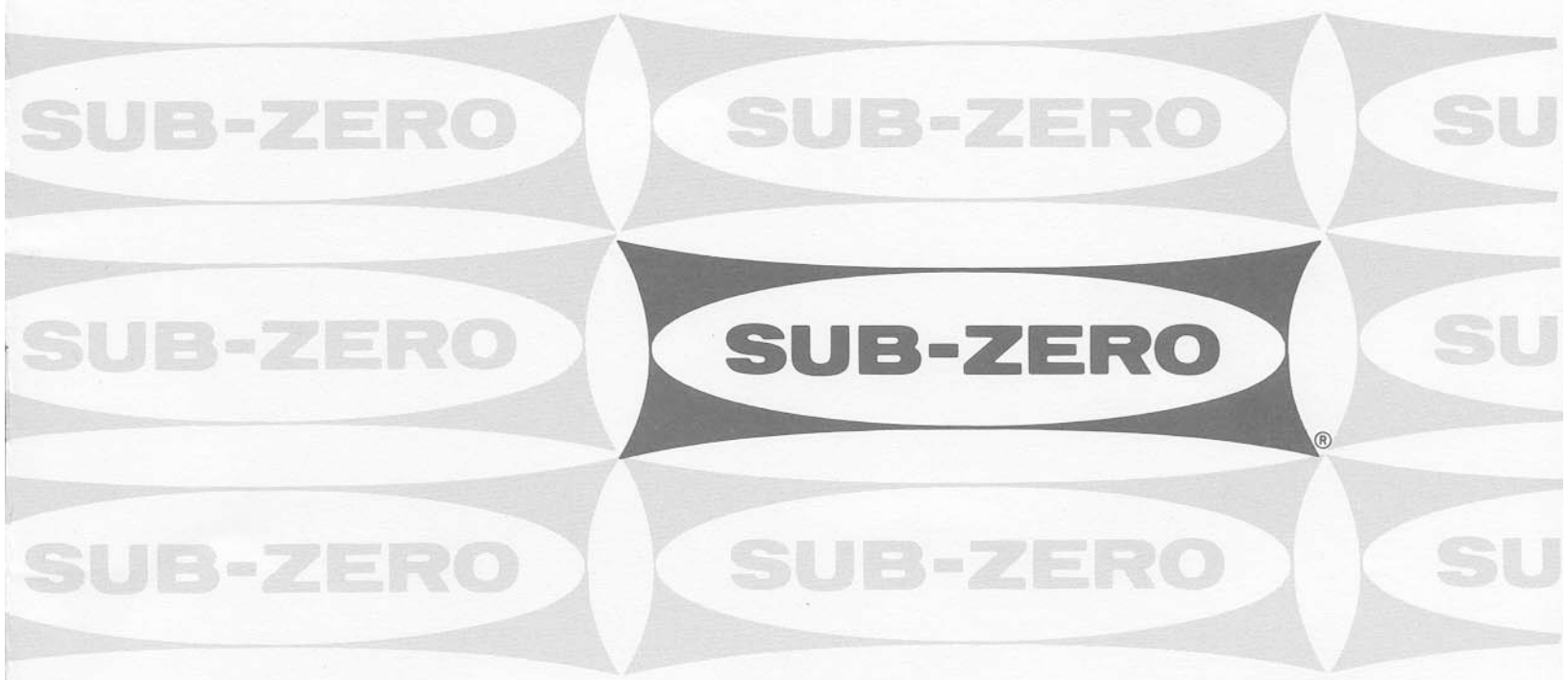

500 Series

TABLE OF CONTENTS

WARRANTY

Sub-Zero 500 Series

- Models 532, 542 and 561 3
- Models 511 and 550 4
- Models 501F and 501R 5
- Model 590 6

Product Operation

- Temperature Controls 7
- Crisper Drawers 7
- Humidity Control 8
- Adjustable Shelves 8
- Roll-Out Refrigerator Basket . . 8
- Door Shelves and Dairy Compartment 9
- Freezer Drawer Removal 9
- Door Closing 10
- Fan Motor Operation 10
- Ice Maker Operation 10
- Automatic Defrost 13
- Master Power Switch 13
- Sounds 13

Product Care

- Maintenance and Cleaning 13-14
- Lighting Information 15-16
- Vacation Time 16
- Vacant House 16

Food Storage Suggestions

- Suggested Storage 17-18
- Product Loading Suggestions . . 17

Service Information 18-19

LOG YOUR MODEL AND SERIAL NUMBER

Have this information ready when calling for service.

MODEL NUMBER

SERIAL NUMBER

INSTALLATION DATE

FACTORY AUTHORIZED SERVICE AGENT
(PHONE NUMBER)



“PROTECTION PLAN”

**Full 5 Year Warranty and Limited 6th Through 12th Year Warranty on the Sealed System
Full 2 Year Warranty on the Total Product**

FULL FIVE YEAR WARRANTY

For five years from the date of original installation, your Sub-Zero warranty covers all parts and labor to repair or replace any components that prove to be defective in materials or workmanship in the sealed system. The sealed system consists of the compressor, condenser, evaporator, drier and all connecting tubing.

FULL TWO YEAR WARRANTY

For two years from the date of original installation, your Sub-Zero warranty covers all parts and labor to repair or replace any part of the product which proves to be defective in materials or workmanship.

LIMITED 6TH THROUGH 12TH YEAR WARRANTY

From the 6th through the 12th year from the date of original installation, your Sub-Zero warranty covers all parts that prove to be defective in materials or workmanship in the sealed system (parts only). The sealed system consists of the compressor, condenser, evaporator, drier and all connecting tubing.

TERMS APPLICABLE TO EACH WARRANTY

All service provided by Sub-Zero under the above warranty must be performed by authorized Sub-Zero service representatives, unless otherwise specified by Sub-Zero. Service will be provided in the home during the normal business hours. This warranty applies only to products installed for normal residential use. A separate nonresidential warranty is available upon request.

The warranty applies only to products installed in any one of the fifty states of the United States, the District of Columbia or the ten provinces of Canada. This warranty does not cover any parts or labor to correct any defect caused by negligence, accident or improper use, maintenance, installation, service or repair, including but not limited to improper removal and reinstallation (whether in the unit or at a remote location) of the condensing unit.

THE REMEDIES DESCRIBED ABOVE FOR EACH WARRANTY ARE THE ONLY ONES WHICH SUB-ZERO WILL PROVIDE, EITHER UNDER THESE WARRANTIES OR UNDER ANY WARRANTY ARISING BY OPERATION OF LAW. SUB-ZERO WILL NOT BE RESPONSIBLE FOR ANY CONSEQUENTIAL OR INCIDENTAL DAMAGES ARISING FROM THE BREACH OF THESE WARRANTIES OR ANY OTHER WARRANTIES, WHETHER EXPRESS, IMPLIED OR STATUTORY.

Some states do not allow the exclusion or limitation of incidental or consequential damages, so the above limitation or exclusion may not apply to you. This warranty gives you specific legal rights and you may also have other legal rights which vary from state to state.

To receive parts and/or service and the name of the Sub-Zero authorized service representative nearest you, contact your Sub-Zero dealer or distributor or contact Sub-Zero Freezer Company, Service Department, P.O. Box 44130, Madison, Wisconsin, 53744-4130 or call: (800) 222-7820.

MODELS 532, 542 AND 561 FEATURES

- | | | |
|--|--|---|
| <ul style="list-style-type: none"> 1) Adjustable Dairy Compartment w/Magnetic Gasket (Dairy Compartment of Model 561 has one section) 2) Egg Trays (Model 561 has one egg tray) 3) Adjustable Door Shelves 4) Four-Sided Magnetic Gaskets 5) Door Closers on Freezer and Refrigerator Doors 6) Removable Toe Plate | <ul style="list-style-type: none"> 7) Deluxe Crispers with Rollers and Humidity Controls (Models 542 and 561 have two crispers) 8) Adjustable Roll-Out Refrigerator Basket 9) Adjustable Glass Shelves — Refrigerator 10) Lighted Ceiling — Refrigerator and Freezer 11) Lighted Refrigerator Control 12) Roll-Out Freezer Baskets (Model 542 has three baskets) | <ul style="list-style-type: none"> 13) Pull-Out Ice Drawer / Automatic Ice Maker 14) Lighted Freezer Control 15) Ice Maker On/Off Switch 16) Adjustable Wire Shelves — Freezer (Model 542 has three shelves) 17) Serial and Model Number Plate 18) Hermetically Sealed Refrigeration Units 19) Front Venting allows unit to be completely built-in |
|--|--|---|

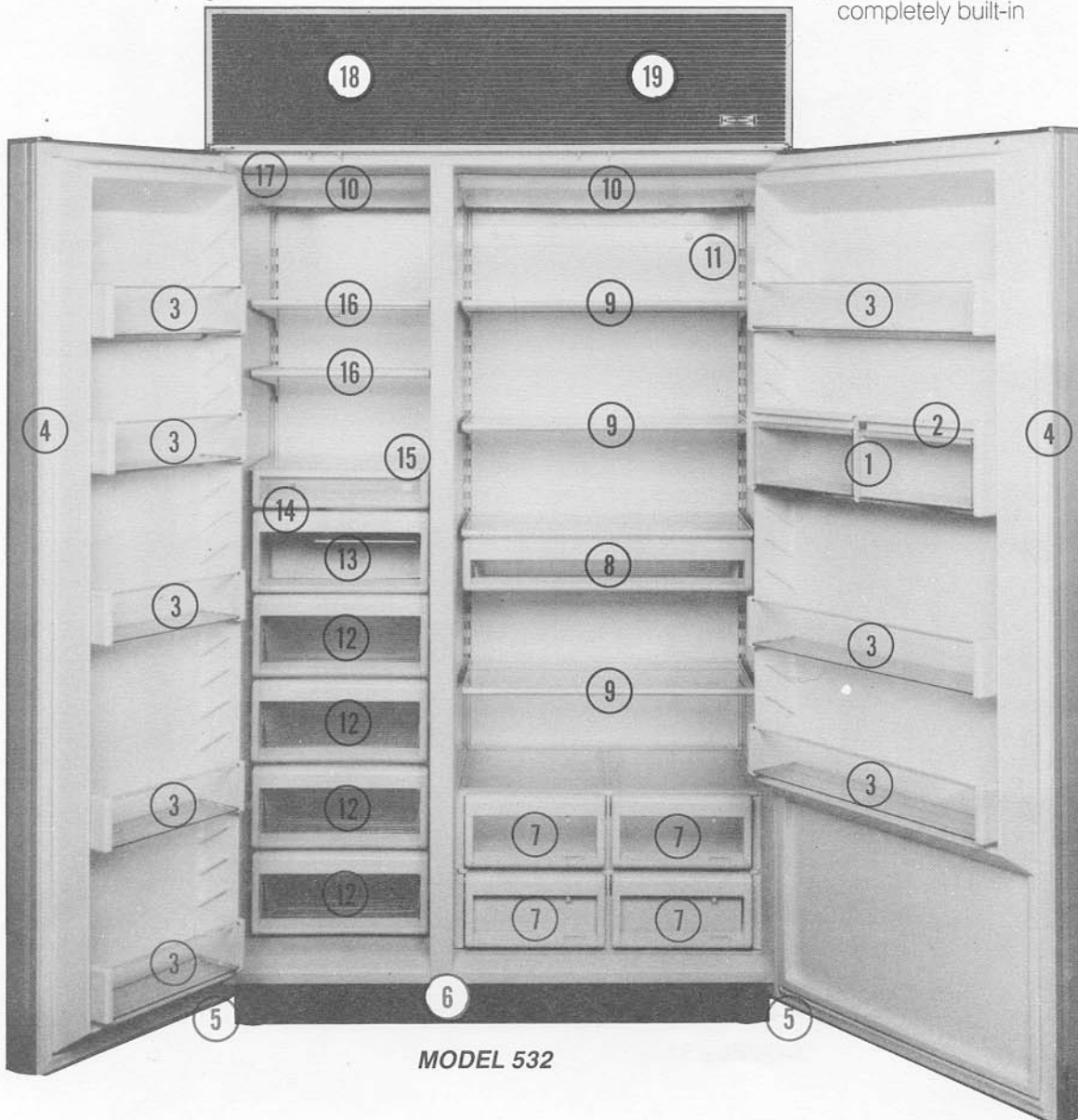

MODEL 532

500 Series

MODEL 511 AND 550 FEATURES

- 1) Adjustable Dairy Compartment w/Magnetic Gasket
- 2) Egg Trays
- 3) Adjustable Door Shelves
- 4) Four-Sided Magnetic Gaskets — Refrigerator and Freezer
- 5) Door Closers on Refrigerator Door and Freezer Drawer
- 6) Removable Toe Plate
- 7) Deluxe Crispers with Rollers and Humidity Controls
- 8) Adjustable Roll-Out Refrigerator Basket
- 9) Adjustable Glass Shelves — Refrigerator
- 10) Lighted Ceiling
- 11) Lighted Freezer Control
- 12) Lighted Refrigerator Control
- 13) Hermetically Sealed Refrigeration Units
- 14) Front Venting allows unit to be completely built in
- 15) Serial and Model Number Plate
- 16) Automatic Ice Maker
- 17) Two Tier Wire Storage Baskets — Freezer
- 18) Roll-Out Freezer Drawer



MODEL 550

MODEL 501F AND MODEL 501R FEATURES

MODEL 501F FEATURES

- 1) Adjustable Door Shelves
- 2) Four-Sided Magnetic Gasket
- 3) Door Closer
- 4) Removable Toe Plate
- 5) Roll-Out Freezer Baskets
- 6) Pull-Out Ice Container / Automatic Ice Maker
- 7) Adjustable Wire Shelves
- 8) Lighted Ceiling
- 9) Lighted Freezer Control
- 10) Serial and Model Number Plate

- 11) Hermetically Sealed Refrigeration Unit
- 12) Front Venting allows unit to be completely built in

MODEL 501R FEATURES

- 1) Adjustable Dairy Compartment w/Magnetic Gasket
- 2) Egg Trays
- 3) Adjustable Door Shelves
- 4) Four-Sided Magnetic Gasket
- 5) Door Closer

- 6) Removable Toe Plate
- 7) Deluxe Crispers with Rollers and Humidity Controls
- 8) Adjustable Roll-Out Refrigerator Basket
- 9) Adjustable Glass Shelves
- 10) Lighted Ceiling
- 11) Lighted Refrigerator Control
- 12) Hermetically Sealed Refrigeration Unit
- 13) Front Venting allows unit to be completely built in
- 14) Serial and Model Number Plate
- 15) Optional D-Style Handle

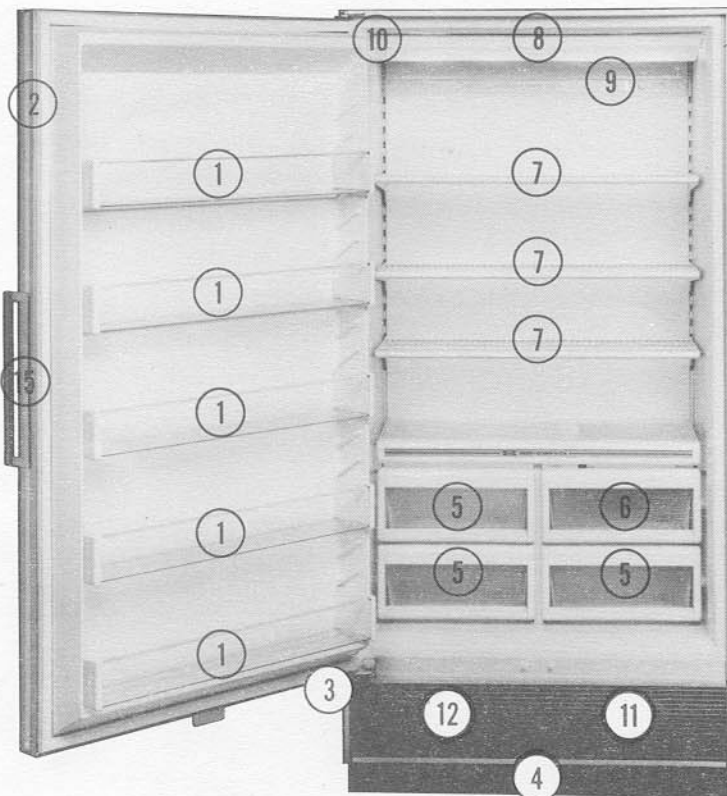

MODEL 501F



MODEL 501R

500 Series

MODEL 590 FEATURES

- 1) Adjustable Dairy Compartment w/Magnetic Gasket
- 2) Egg Tray
- 3) Adjustable Door Shelves
- 4) Four-Sided Magnetic Gaskets (Refrigerator and Freezer)
- 5) Door Closers on Freezer and Refrigerator Doors
- 6) Removable Toe Plate
- 7) Deluxe Crispers with Rollers and Humidity Controls
- 8) Adjustable Roll-Out Refrigerator Basket
- 9) Adjustable Glass Shelves (Refrigerator)
- 10) Lighted Ceiling (Refrigerator and Freezer)
- 11) Lighted Refrigerator Control
- 12) Roll-Out Freezer Baskets
- 13) Bulk Ice Dispenser
- 14) Lighted Freezer Control
- 15) Icemaker On/Off Switch w/Indicator Light
- 16) Adjustable Wire Shelves (Freezer)
- 17) Model and Serial Plate
- 18) Hermetically Sealed Refrigeration Units
- 19) Self-Vented Panellized Grille Allows Unit to be Completely Built-In
- 20) Freezer Utility Rack
- 21) Master Power Switch
- 22) Automatic Icemaker
- 23) Ice and Water Dispenser

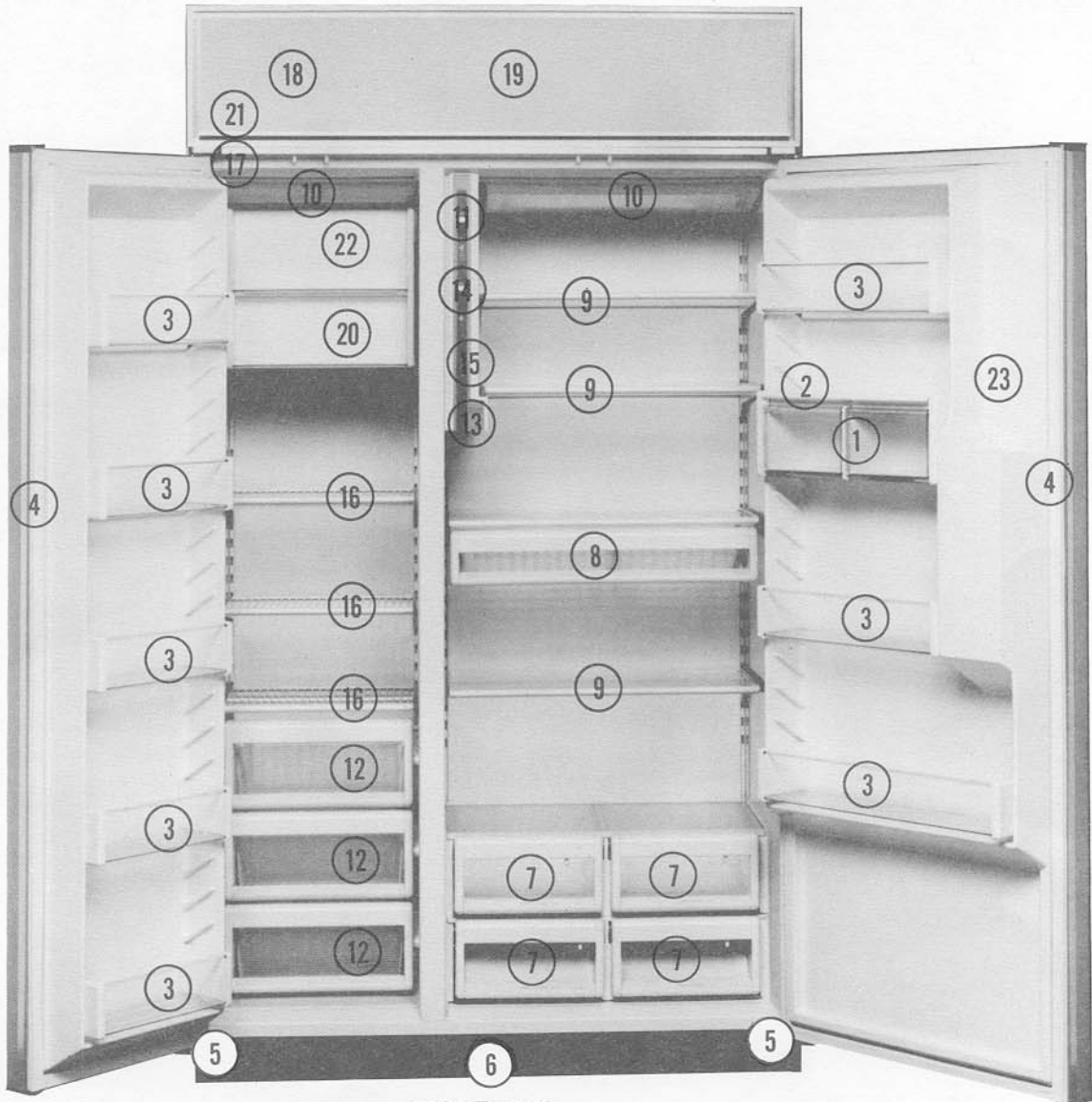

MODEL 590

PRODUCT OPERATION

The importance of the installation of your Sub-Zero cannot be over-emphasized. **The proper installation of your unit is the responsibility of the selling dealer or installer.** Any questions or problems pertaining to the installation should be directed to the selling dealer.

TEMPERATURE CONTROLS

Your new refrigerator/freezer was thoroughly inspected and tested before it was shipped from the Sub-Zero factory. During these procedures, the temperatures were preset to maintain approximately 38 degrees in the refrigerator section and approximately 0 degrees in the freezer section. If you wish to adjust the temperature, simply turn the control dial. The illuminated dial indicates the control setting, #1 warmest to #10 coldest. See Figures 1, 2, and 3.

You should be aware it is normal for temperatures to fluctuate slightly depending on external influences, such as: an open door for extended periods, the degree of humidity present and room temperature.

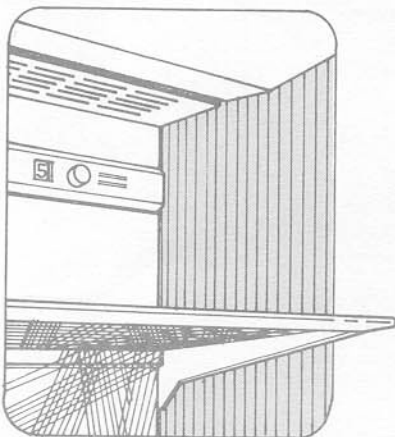

Figure 1

NOTE: Always allow 24 hours for the refrigerator to reach the temperature you set.

MODELS 532, 542 AND 561

The refrigerator control is located on the back wall of the refrigerator near the top right. See Figure 1.

The freezer control is located on the freezer panel just above the ice drawer. To adjust, pull the drawer out, on the left side of the panel turn the control dial until the desired setting appears on the panel. See Figure 2.

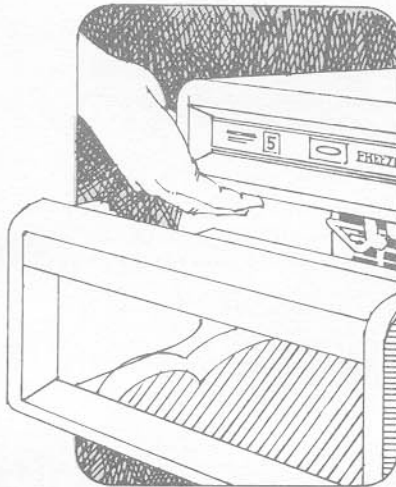

Figure 2

MODELS 511 AND 550

The refrigerator and freezer controls are both located on the back wall of the refrigerator near the top. The refrigerator control is on the right and the freezer control is on the left. See Figure 1.

MODELS 501F AND 501R

The temperature control for each model is located on the back wall of the unit near the top right. See Figure 1.

MODEL 590

The refrigerator and freezer controls are both located **inside** the refrigerator section on the left hand side at a convenient level. See Figure 3.

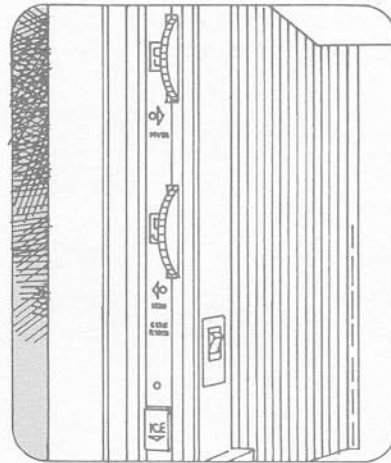

Figure 3

CRISPER DRAWERS

To remove your crisper drawer, pull open until drawer stops. Raise front of crisper and pull out as shown in Figure 4. **To reinstall:** With the front of the crisper raised, insert crisper into the tracks. See Figure 4.

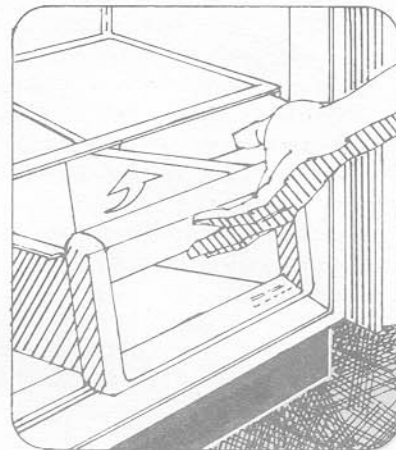

Figure 4

500 Series

PRODUCT OPERATION

HUMIDITY CONTROL

The humidity level in each crisper may be controlled for the storage of meats, fruits or vegetables. (See "Food Storage Suggestions," (See pages 17 and 18). Adjust the slide on the front, to the left for higher humidity, or to the right for lower humidity. See Figure 5.

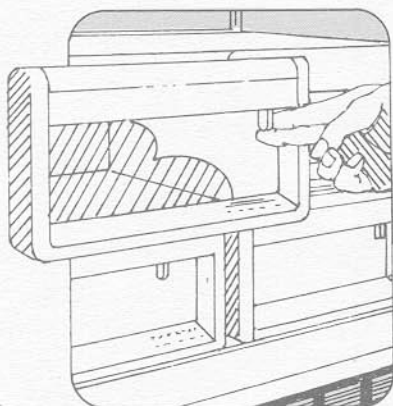

Figure 5

ADJUSTABLE SHELVES

To remove or adjust shelves, tilt the shelf up at the front, then lift up and out of tracks on rear wall of refrigerator or freezer as shown in Figure 6. **Note:** If door is only allowed to open 90°, in order to clear door shelves, lift and tilt right end of shelf up and left end down, and lift out clearing door shelves.

Caution should be exercised when handling refrigerator glass shelves to prevent breakage or scratching of interior. To replace shelves:

Select desired shelf height. With shelf front raised slightly, insert shelf in tracks at rear of unit. Then lower front of shelf until it locks into position.

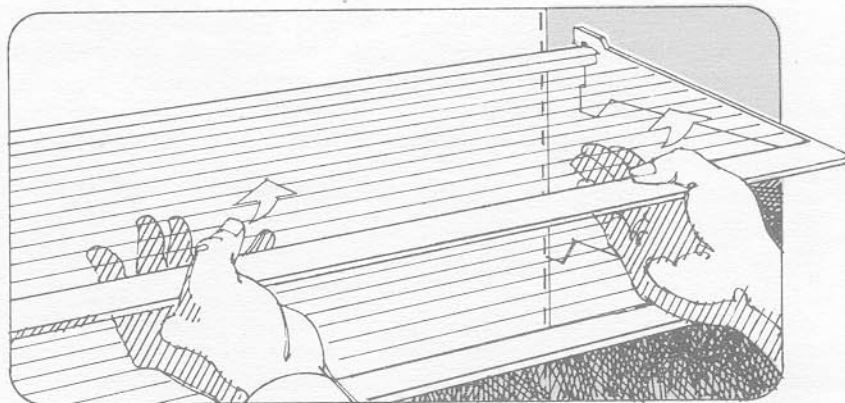

Figure 6

ROLL-OUT REFRIGERATOR BASKET

This basket rolls in and out for easy access to small containers and food items.

To remove: Pull basket out, lift up on the front and then out as shown in Figure 7 below. **Note:** If door is

only allowed to open 90°, then entire basket and shelf must be removed as one unit in order to clear door shelves. To do this, place one hand palm up under the roll out refrigerator basket and lift out of the support track. Tilt right end upward and remove clearing door shelves.

To replace: With the front of the basket raised, insert the basket roller into tracks and push in.

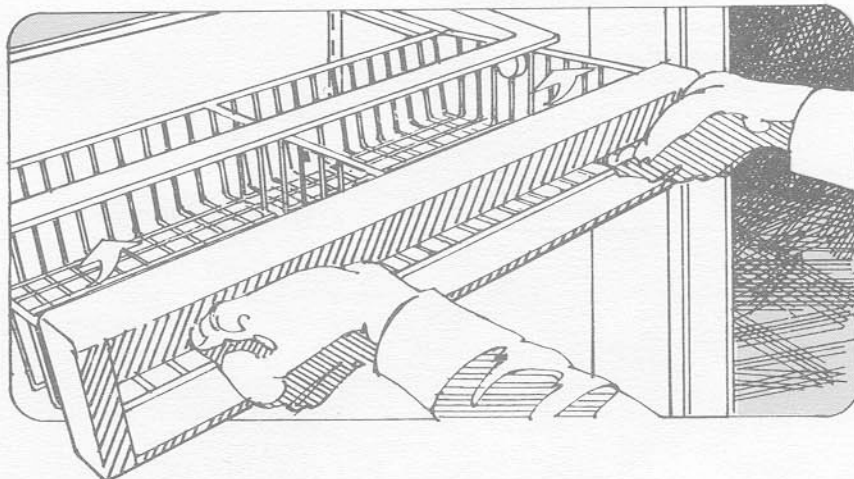

PRODUCT OPERATION

DOOR SHELVES AND DAIRY COMPARTMENT

The door shelves and dairy assembly are adjustable within the guides of the door liner. See Figure 8.

To remove: Lift straight up and out from the bottom. **To reinstall:** Select desired position and push down into guides.

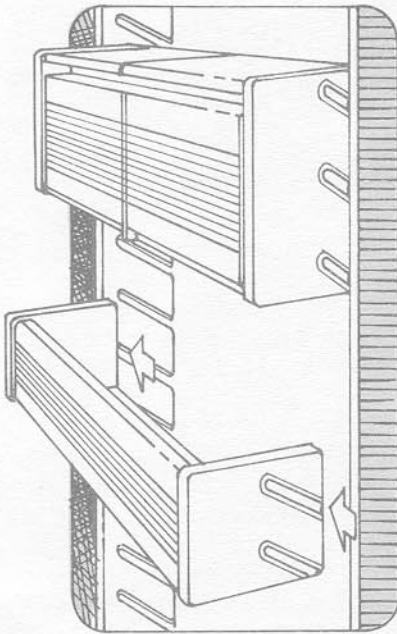

Figure 8

FREEZER DRAWER REMOVAL

MODELS 511 AND 550

The freezer drawer will stop before coming all the way out of the unit. Lift up evenly on each side of the drawer, while holding the top basket in place and pull out. The drawer and basket will come out together as in Figure 9.

▲ CAUTION

IMPORTANT: Unload the drawer before removing. CAUTION should be taken when removing the drawer, keeping your feet clear from under the drawer.

MODELS 532, 542, 561 AND 590

To remove: Pull open until drawer stops. Raise front of drawer and pull out. **Note:** If door is only allowed to open 90°, in order to clear door shelves, we

recommend the following procedure. Pull ice drawer out until it stops. Lift back of ice drawer up, clearing carrier assembly. Pivoting the right side of ice drawer toward you, lift ice drawer out. Remove the remaining drawers in sequence by lifting up and out in the same manner, tilting up sharply as soon as the rollers leave the tracks. (If drawer sticks during removal, lifting up will disengage the rollers). **To reinstall:** Reverse procedure. **Note:** To replace the ice drawer, make sure the white carrier assembly is pulled completely forward and hang the back lip of the drawer on the top of the carrier assembly.

MODEL 501F

To remove: Pull open until drawer stops, raise front of drawer and pull up and out.

To reinstall: Reverse procedure.

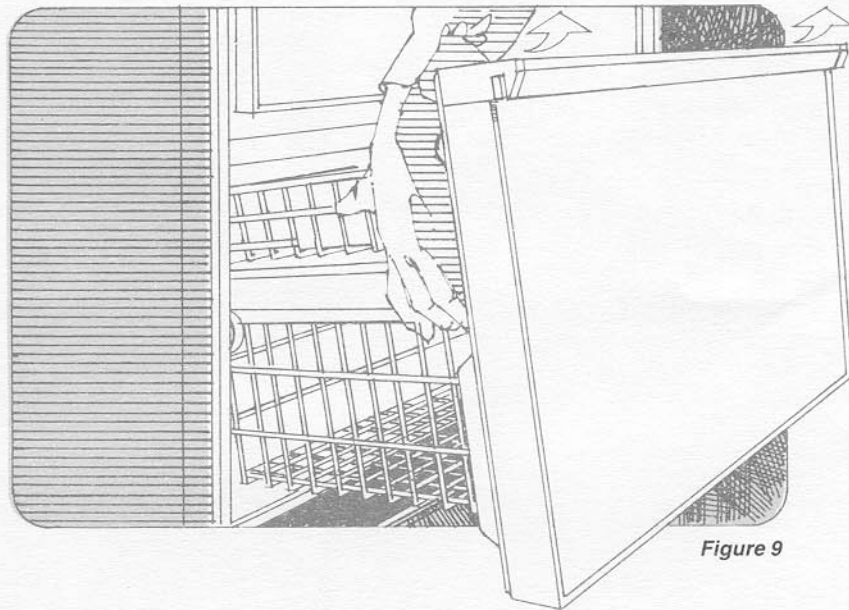

Figure 9

500 Series

PRODUCT OPERATION

DOOR CLOSING

MODELS 532, 542, 561, 501F, 501R AND 590

Refrigerator and freezer doors are both equipped with a spring loaded door closure-mechanism. As the doors are closed, the door closure engages to assist in the closing and sealing of the doors.

MODEL 550 AND 511

Refrigerator door: Your refrigerator door is equipped with a door closing cam to assist in the closing of the door. With the door opened to approximately 120° the cam will hold in the open position if the door is stopped. If the door continues to swing open, have the unit checked for proper leveling **by your installer or dealer.**

As you close the door, the cam will take over at approximately the 15° position and assist in the door closing.

Freezer drawer: The freezer drawer is equipped with a self-closing mechanism. The incline, built into the roller assemblies on the basket, uses gravity to assist in the drawer closing.

FAN MOTOR OPERATION

All units have one fan behind the grille to cool the compressor area. This fan runs with either compressor.

ICEMAKER OPERATION

The icemaker in your Sub-Zero is fully automatic and has been factory pre-tested. To put into operation it requires only a connection to the house water supply.

MODELS 501F, 511 AND 550

The icemaker is shut off when the container is removed from the freezer basket. Replace the ice container and ice production is restored. For Models 511 and 550 see Figure 10 and for Model 501F see Figure 11.

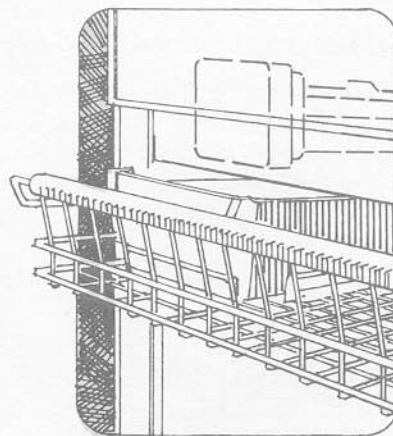

Figure 10

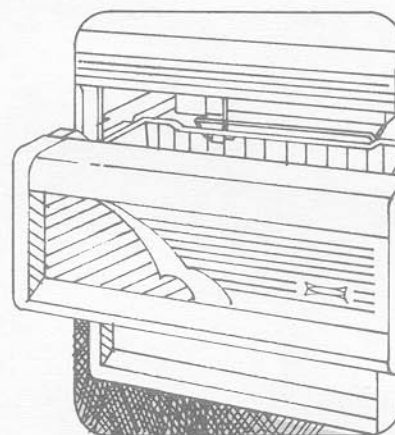

Figure 11

MODELS 532, 542 AND 561

The icemaker may be turned off and on by the switch on the front of the freezer control panel. See Figure 12.

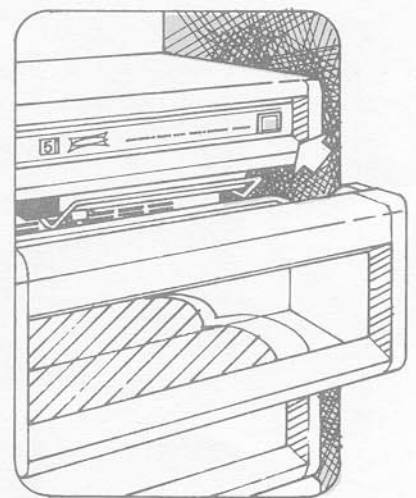

Figure 12

To remove the ice drawer for Models 532, 542 and 561: Pull it out until it stops and lift back of ice drawer up clearing carrier assembly, and lift ice drawer out.

Note: If door is only allowed to open 90°, repeat above procedure, but when lifting ice drawer out, pivot right side of ice drawer toward you and out. This will allow drawer to clear the door.

PRODUCT CARE

MODEL 590 WATER DISPENSER

This automatic water and ice dispensing product offers the convenience of dispensing both chilled water and ice from the product without having to open the doors. See Figure 13.

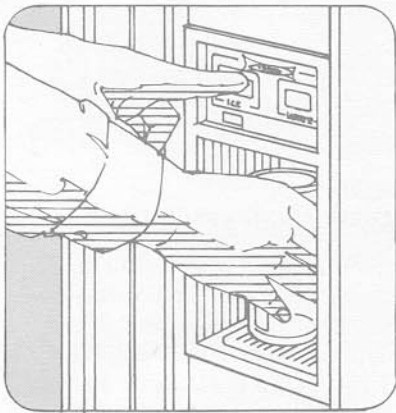

Figure 13

The water dispenser operates as follows: To operate the water dispenser, the water dispenser switch must be depressed continuously for the required amount. This switch is located on the refrigerator door glasswell. See Figure 13. The very first time the water dispenser is operated, it will be necessary to flush and purge the water system and water storage tank **for three minutes**. This procedure will clear out any air in the system as well as any foreign material that occurs with a new plumbing connection in the home.

The chilled water container is mounted inside the refrigerator section. It will take several hours to chill the water to the refrigerator temperature upon the original fill or if a significant amount of water is used.

CAUTION

Do not run the water dispenser switch any longer than 8 minutes continuously as this will damage the equipment.

MODEL 590 ICE DISPENSER

The ice dispenser operates as follows: To operate the ice dispenser, the ice dispenser switch must be depressed continuously for the required amount. This switch is located on the refrigerator door glasswell. See Figure 13.

After original start-up of the ice-maker operation, it will be necessary to discard the first few batches of ice as they may be discolored due to the new plumbing connection to the home.

The ice dispenser feature can deliver ice in two different ways: (1) By inserting a glass into the glasswell and then depressing the ice dispenser switch as in Figure 13, ice cubes will automatically dispense into the glass. (2) If a larger quantity of ice is required, open up the refrigerator door, position an ice container underneath the ice dispenser chute and then depress the button for bulk ice dispensing. See Figure 14.

CAUTION

Do not run the ice dispenser switch any longer than 8 minutes continuously as this will damage the equipment.

CAUTION

Do not use a fragile glass as the ice crescents dropping into the glass from the ice dispenser may break this type of glass.

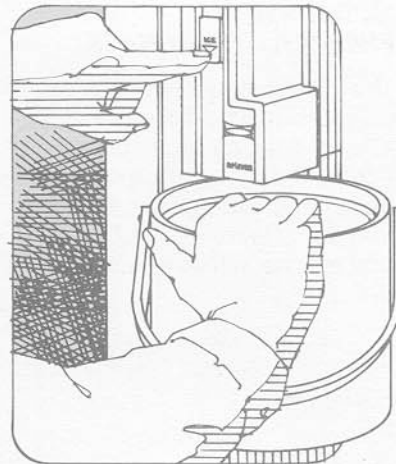

Figure 14

MODEL 590 ICE DISPENSER OPERATING TIPS

- 1) **If no ice**, is the ice system switch on? See Figure 18.
- 2) Make sure there is a supply of ice in storage container. See "Ice Storage Container" page 12.
- 3) Make sure storage container is all the way in to insure proper engagement of auger motor to back of container. If ice container is not all the way back, push on container and ice dispenser switch at the same time to properly engage.
- 4) Make sure freezer utility rack is properly installed as this insures proper ice storage container positioning. See "Freezer Utility Rack" page 12.
- 5) Press ice dispenser switch. If no auger motor noise is heard, wait 5 minutes and try again. On second try if no auger motor noise is heard, call your local Factory Authorized Service Agency.
- 6) If the ice dispenser is not used for an extended period, the ice will tend to fuse together. It will be necessary to discard old ice.

500 Series

PRODUCT CARE

MODEL 590 FREEZER UTILITY RACK

The freezer utility rack is specifically designed to accommodate and hold freezer juice containers. For the removal of the freezer utility rack, lift up and pull out at the bottom with one hand and then support the top with the other hand as in Figure 15.

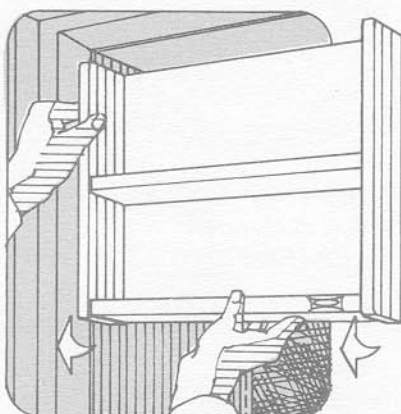

Figure 15

MODEL 590 ICE STORAGE CONTAINER

The ice storage container holds an ample supply of ice for the average family's daily consumption.

The ice storage container can be removed for discarding unused ice or for general cleaning purposes.

To access the ice storage container, the freezer utility rack must be first removed. See Figure 15. To remove the ice storage container, lift up on the ice container handle and pull out having the bottom of the ice storage container supported with the other hand as shown in Figure 16.

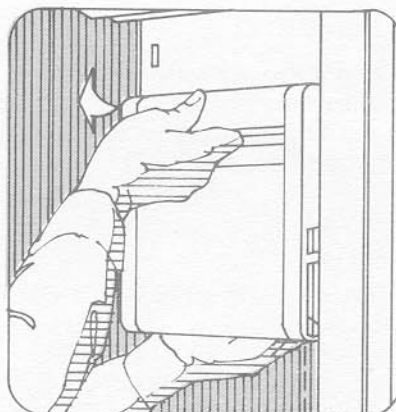

Figure 16

MODEL 590 LIGHT BULB AND LIGHT SWITCH IN DISPENSER UNIT

The door dispenser light switch is located in the upper left hand portion of the water and ice dispenser glasswell. Depress the light switch to turn the dispensing light on and off. **NOTE:** In the off mode the light will activate when either the water or ice switch is depressed. The light bulb can easily be replaced with a 7 watt appliance bulb. See Figure 17. **NOTE: Dispenser light will remain on for 5 seconds after dispenser switch is released.**

▲WARNING

Shut off circuit breaker to refrigerator or master power switch before attempting this maintenance. See Figure 19.

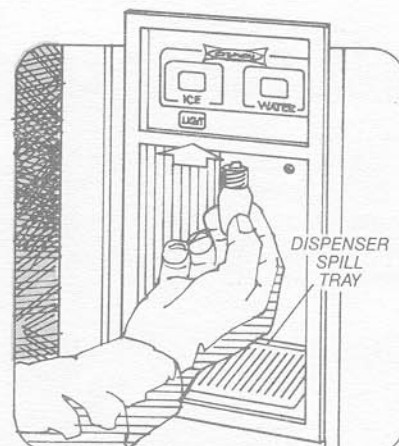

Figure 17

MODEL 590 DISPENSER SPILL TRAY

At the bottom of the water and ice dispenser, there is a spill tray assembly. This tray will catch and evaporate small spills. **NOTE: There is no drain in this area; therefore do not pour water into the spill tray.** See Figure 17. To clean this area, depress the front left corner of the spill plate and it can easily be removed.

MODEL 590 ICEMAKER SWITCH

This switch is located in the refrigerator section on the right hand side of the Control Panel Assembly. See Figure 18. **NOTE:** When the switch is on, the icemaker system light will be illuminated. See Figure 18. The design of this switch is to allow the icemaker and ice dispenser to be shut off for extended vacation periods. During these vacation periods, we recommend the icemaker switch be turned off. Then the ice storage container can be removed, emptied and returned to its location. See Figure 16. This prevents the unused ice, over a period of time, from shrinking and sticking together, possibly causing a "no ice" situation.

PRODUCT OPERATION

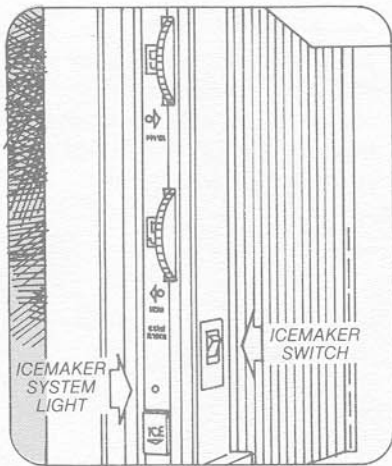

Figure 18

ICE PRODUCTION ALL MODELS

The level of ice in the ice containers is controlled by an ice level arm. When the containers are filled with ice the ice level arm senses the level and shuts down the icemaker. As ice is used, the level drops and the level arm signals the icemaker to restore ice production.

These icemakers are designed to produce an adequate supply of ice for normal family consumption. The length of time between ice harvest cycles will vary depending on load conditions, door openings and ambient room temperatures. On the average, you can expect a harvest of ice every 2 hours.

If ice is not used regularly it will tend to fuse together. To avoid this, empty the ice container periodically.

AUTOMATIC DEFROST

For your convenience your Sub-Zero unit is equipped with an automatic defrost system. The refrigerator section will defrost

during each off cycle of the refrigerator. The freezer section is controlled by a timer which defrosts as needed.

MASTER POWER SWITCH

MODEL 590

The Model 590 features a Master Power Switch. This switch, which is located behind the top grille, will turn off all electrical power to the equipment. See Figure 19. This eliminates having to shut power off at the circuit breaker or having to pull the power plug from the wall receptacle. This switch can be used for either shutting down the equipment for servicing or during extended vacations.

In order to access this switch, the front inner grille panel assembly must be first removed (refer to panellized grille removal instructions on Page 14, Figure 23).

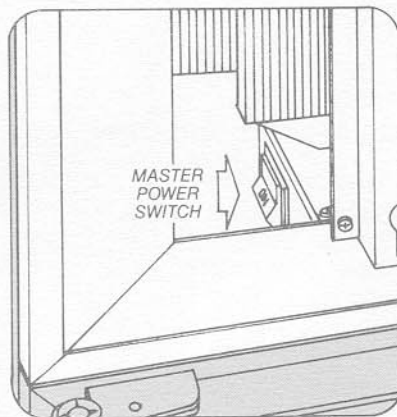

Figure 19

SOUNDS

Certain noises may be evident with the normal operation of the unit. Surrounding acoustics like walls, floors and cabinets may affect the sound level of your unit.

A gurgling sound or running water sound may be evident as the refrigerant circulates through the tubing.

In Model 590, the ice dispenser valve within the refrigerator door snaps closed 5 seconds after either the water or ice dispenser switch is released.

During the icemaker cycle you may hear the sound of ice dropping into the container or of the solenoid valve while refilling the icemaker with water.

During the freezer defrost you may hear crackling and/or sizzling as the heat from the defrost element clears the frost from the freezer coil and water runs into the defrost water pan.

While the compressors are in operation a slight hum may be evident. During the startup and shutdown of the compressor, some vibration may occur lasting only a few seconds.

MAINTENANCE AND CLEANING

⚠ CAUTION

We recommend for maintenance and cleaning, that the circuit breaker or master power switch if applicable to the refrigerator be shut off and protective gloves (when cleaning the condenser) be worn.

CONDENSER: To insure proper performance, the cleaning of your unit's condenser is required. This should be performed every 3 to 6 months under normal use. To clean, remove grille. See page 14.

500 Series

PRODUCT CARE

STANDARD GRILLE REMOVAL MODELS 532, 542, 561, 511 AND 550

Remove center grille screw. Tilt the grille forward at the top and release the spring(s) from behind the grille and lift off. See Figure 20. **To reinstall:** reverse procedure.

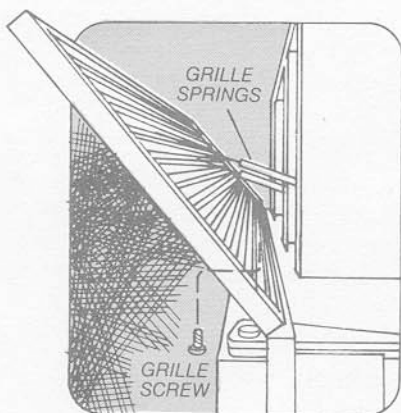

Figure 20

GRILLE REMOVAL MODELS 501F AND 501R

To remove grille, remove two black screws located in the lowest louver in the grille. Tilt the bottom of the grille out and away, it will release from the top of the grille. See Figure 21. **To reinstall:** reverse procedure.

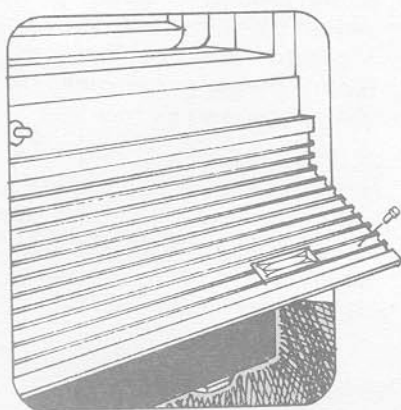

Figure 21

PANELLIZED GRILLE REMOVAL

The optional panellized grille which is removed by lifting up (1) and then pulling out at the bottom (2) and then down to release from the grille mounting bracket (3). See Figure 22.

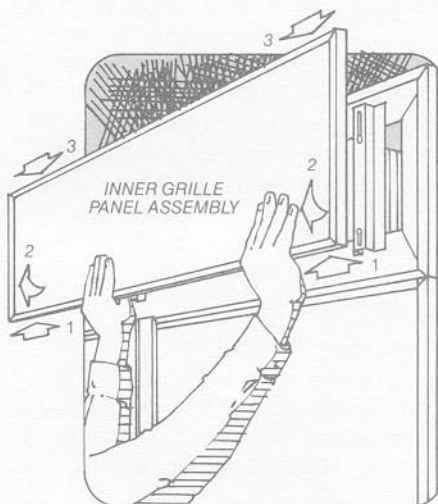

Figure 22

CLEANING PROCEDURE

Use "soft" bristle brush and vacuum hose to remove the accumulation of dust and lint particles on the condenser (radiators). See Figure 23 for Models 511, 532, 542, 561, 550 and 590. See Figure 24 for Models 501F and 501R.

CAUTION

Failure to properly clean this area could result in temperature loss, or possible mechanical failure in both refrigerator and freezer.

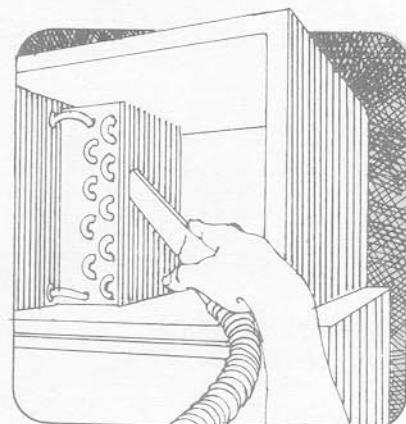

Figure 23

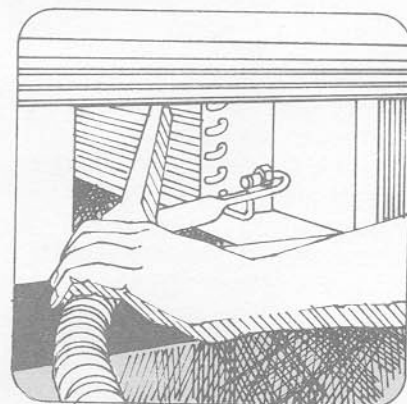

Figure 24

INTERIOR: For cleaning of interior surfaces and removable parts of your refrigerator/freezer, wash with a mild solution of soap and **lukewarm** water to which a small amount of baking soda has been added. Use of vinegar is not recommended. Rinse and dry thoroughly. Avoid getting water on lights or control dials.

PRODUCT CARE

590 Exterior Surfaces: Same as interior for **all** Factory Supplied Exterior Surfaces.

590 Glasswell cleaning: Wipe up spills after removing dispenser spill tray. See Figure 17. Clean with a mild solution of soap and water to which a small amount of baking soda has been added.

▲WARNING

Shut off electrical power to equipment before cleaning product with soap and water solution.

▲CAUTION

Do not submerge or pour hot water over cold glass shelves.

CLEANING OUT THE ICE CHUTE MODEL 590

On occasion, ice crescents may become lodged in the ice chute. The ice chute is a clear plastic housing that directs ice from the freezer section's ice storage container to the refrigerator door ice dispenser. This may prevent the icemaker from supplying ice to either the ice dispenser or the bulk ice dispenser. We have made available access to the ice chute to allow a convenient way to unblock any obstructions.

The ice chute is located behind the freezer control panel, mounted to the left hand side of refrigerator. The side panel is removed by holding the bottom of the side panel and pushing rearward, then

pulling out as in Figure 25. Once the panel is removed, the clear plastic ice chute will be visible as well as any obstruction.

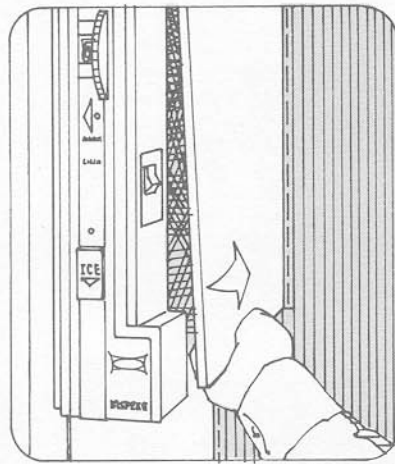

Figure 25

To remove the side cover of the ice chute, depress the two side locking tabs, then pull up and out. See Figure 26.

To reinstall, make sure the bottom section of the ice chute is installed first; the outside front cover lip fits inside the stationary portion. Then push the two assemblies together and secure the self-locking tabs closed.



Figure 26

LIGHTING INFORMATION

IMPORTANT: When the refrigerator doors (all models) or freezer doors (501F, 532, 542, 561 and 590) are left open for an extended period of time, the lights may go off. This design protects the internal parts from overheating. To reset the light switch, close the door(s) for approximately 15 to 30 minutes.

▲CAUTION

For your safety, the circuit breaker to the refrigerator should be shut off (or on Model 590, the master power switch is turned off, see page 13) before replacing bulbs. Protective gloves should be worn when handling light bulbs (40 watt maximum).

REFRIGERATOR LIGHTING

The light shield in the top of the refrigerator must be removed to replace the light bulbs. To do so: Place your hands on the back edge of the shield and pull towards you to release (this shield may have a snug fit). Drop the front edge of the shield out of the channel and remove. The light bulbs are now accessible. To reinstall: Engage front edge of shield into channel and snap the back edge up into position. See Figure 27 on page 16.

500 Series

PRODUCT CARE

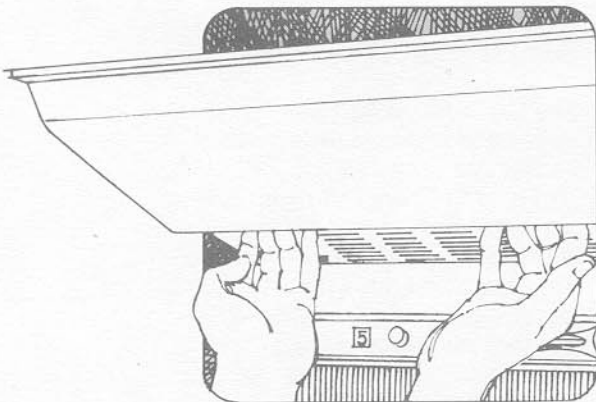

Figure 27

FREEZER LIGHTING MODELS 532, 542, 561 AND 501F

The overhead lighting is accessed the same as described for "Refrigerator Lighting," on page 15.

FREEZER CONTROL LIGHTING MODELS 532, 542 AND 561

Additional freezer lighting is located behind the control panel.

To replace: Remove ice container, reach behind the control panel and unscrew bulb. See Figure 28.

FREEZER BASKET LIGHTING MODELS 532, 542 AND 561

Below the icemaker, mounted on the back wall of the freezer, is the lower freezer lighting. To remove the light shield and access the bulb, gently compress the shield to release the top and then the bottom. See Figure 28. **To reinstall:** Engage the bottom first and then compress and insert the top.

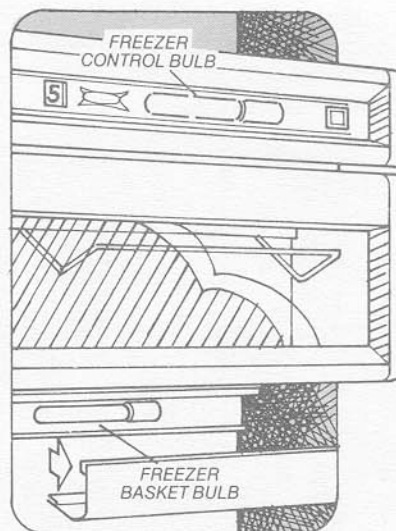

Figure 28

FREEZER LIGHTING MODELS 511 AND 550

The freezer lighting is supplied by bulbs in the top of the freezer (Model 511 has one bulb, Model 550 has two bulbs), mounted to the front of the evaporator cover. The bulbs are accessible by opening the freezer drawer and unscrewing the bulb from the top of the freezer.

FREEZER LIGHTING MODEL 590

The overhead lighting is accessed the same as described for "Refrigerator Lighting." See Figure 29.

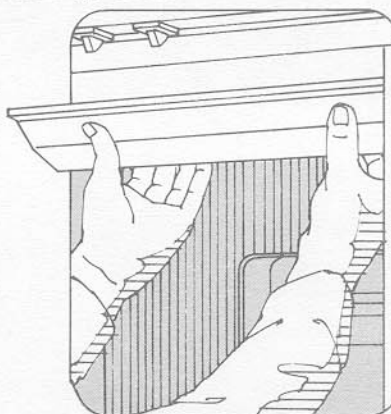

Figure 29

VACATION TIME

For extended vacations: The control(s) to your refrigerator or freezer should be turned off or the circuit breaker can be shut off (on Model 590, the master power switch, See page 13.) Empty all contents in the refrigerator/freezer. **BLOCK THE DOORS OPEN SLIGHTLY WHEN THE UNIT IS NOT IN USE.** About one inch space will let fresh air in to keep the interior dry.

For short vacations: Remove all perishable items. Shut off the icemaker switch (see Icemaker Operation page 10) and dump the unused ice out of the ice container. Do not change the settings of your controls.

VACANT HOMES

If for any reason this unit is put into service on a temporary basis, and later shut off, the doors should be blocked open to allow fresh air to circulate within the compartment. Also, the circuit breaker to the refrigerator or freezer should be shut off (on Model 590, the master power switch, see page 13).

CAUTION: The moisture developed during even the shortest amount of running time could attack the metal.

FOOD STORAGE SUGGESTIONS

SUGGESTED STORAGE*

New techniques are constantly being developed. Consult the College or County Extension Service or your local Utility Company for the latest information on freezing and storing foods.

**U.S. Department of Agriculture*

Fresh Food Storage

Shelf life of fresh foods may vary, depending on the freshness at time of purchase. To keep your foods fresher longer, follow the recommended storage procedures.

Vegetables

Wash in cool water and drain. Store in air-tight container or plastic wrap. Most vegetables should be stored in higher humidity.

Fruits

Wash and dry. Store in crisper compartment. More aromatic fruits should be stored in plastic bags. Most fruits should be stored in lower humidity.

Prepackaged Meats

Store in original packaging. After opening rewrap tightly in plastic wrap or aluminum foil.

Unfrozen Fish, Meats, and Poultry

Remove store wrappings. Then rewrap in plastic wrap, foil or waxed paper, and refrigerate immediately.

Eggs

Store unwashed in carton or portable egg tray. Use within 2 weeks.

Milk, Cream, Cottage Cheese

Keep carton closed. Store on refrigerator shelf and use within 5 days.

Cheese

Store in original packaging until ready to use. After opening, rewrap tightly in plastic wrap or aluminum foil.

Left Overs

Let cool and cover tightly with plastic wrap or foil. Airtight plastic containers work well to prevent drying out and odor transfer.

Freezer Storage

Foods should be wrapped in material designed for frozen food storage. The wrap must be sealed so as not to allow air or moisture through the wrapping. **DO NOT refreeze thawed meats.**

Ice Cream

The firmness of the ice cream will depend on the cream content of the ice cream. The higher quality ice creams usually have a higher cream content requiring colder freezer temperatures to maintain its firmness. Soft ice cream is not always an indication of a temperature problem.

PRODUCT LOADING SUGGESTIONS

Items that inhibit the proper closing of your doors will affect the temperatures and should not extend beyond the front of your shelves or beyond the face of your door shelf assemblies. DO NOT fill your freezer with large quantities of unfrozen foods expecting to "fast freeze" these items. Space out new unfrozen items to allow for air circulation for best freezing results.

500 Series

FOOD STORAGE SUGGESTIONS

SERVICE INFORMATION

Eating quality drops after time shown in chart.

	IN REFRIGERATOR AT 35° to 40° F	IN FREEZER AT 0° F
Fresh Meats		
Roasts (Beef and Lamb)	3 to 5 days	6 to 12 months
Roasts (Pork and Veal)	3 to 5 days	4 to 8 months
Steaks (Beef)	3 to 5 days	6 to 12 months
Chops (Lamb)	3 to 5 days	6 to 9 months
Chops (Pork)	3 to 5 days	3 to 4 months
Ground and Stew Meats	1 to 2 days	3 to 4 months
Variety Meats	1 to 2 days	3 to 4 months
Sausage (Pork)	1 to 2 days	1 to 2 months
Processed Meats		
Bacon	7 days	1 month
Frankfurters	7 days	1/2 month
Ham (Whole)	7 days	1 to 2 months
Ham (Half)	3 to 5 days	1 to 2 months
Ham (Slices)	3 days	1 to 2 months
Luncheon Meats	3 to 5 days	Freezing not recom- mended
Sausage (Smoked)	7 days	
Sausage (Dry and Semi-Dry)	14 to 21 days	
Cooked Meats		
Cooked Meats and Meat Dishes	3 to 4 days	2 to 3 months
Gravy and Meat Broth	1 to 2 days	2 to 3 months
Fresh Poultry		
Chicken and Turkey (Whole)	1 to 2 days	12 months
Chicken (Pieces)	1 to 2 days	9 months
Turkey (Pieces)	1 to 2 days	6 months
Duck and Goose (Whole)	1 to 2 days	6 months
Giblets	1 to 2 days	3 months
Cooked Poultry		
Pieces (Covered with Broth)	1 to 2 days	6 months
Pieces (Not Covered)	3 to 4 days	1 month
Cooked Poultry Dishes	3 to 4 days	4 to 6 months
Fried Chicken	3 to 4 days	4 months
(Other than for meats and poultry)		FREEZER
Most fruits and vegetables		8-12 months
Lean fish		6-8 months
Fatty fish, rolls and breads, soups, stew, casseroles		2-3 months
Cakes, pies, sandwiches, leftovers (cooked), ice cream (original carton)		1 month max.

Before calling for service —
If you think your refrigerator or freezer is not operating properly check the following before calling your Sub-Zero Factory Authorized Service Agency or dealer. This may save you time and the expense of a service call.



If Refrigerator/Freezer is not operating —

- Is there electrical power to equipment?
- Is home fuse blown or circuit breaker off?
- Is refrigerator/freezer control on?
- Is your condenser clean?
- Has either door been left open? Be sure no foods are obstructing proper door closing.
- If still not running, unit may be in defrost; wait 30 minutes to see if unit will restart.

If Refrigerator/Freezer is warmer than usual —

- Is control set properly?
- Has door been open too long?
- Have you recently added a large quantity of food?

If Refrigerator/Freezer runs too much —

- Is condenser behind grille clean? See pages 13 and 14.
- On hot days and warm room ambients the motor runs longer.
- Have doors been open for extended times or large amounts of food added?

If Refrigerator/Freezer is frosted up —

- Have doors been left open?
- Are doors closing and sealing properly? Contact your dealer if door not adjusted properly.
- When opening the freezer drawer you may notice side to side motion in the drawer. This motion is normal with the tolerance built-in to the drawer slides. When the drawer is closed it will automatically adjust and close with the proper alignment.

If you hear unusual noises —

- These may be normal operating sounds (see page 13, “**Sounds**”).

If condensation forms inside the unit —

- This is normal during high humidity and frequent door openings.
- Are doors closing and sealing properly?

If condensation forms on the outside —

- It is possible during periods of high humidity some condensation could appear. This condition will subside when humidity levels drop. If condensation is excessive contact your Sub-Zero Factory Authorized Service Agency.
- Be sure doors are closed and gaskets are sealing.

If it is too hot around freezer compartment —

- Clean condenser (see pages 13 and 14).

If no ice —

- Models 511, 550 and 501F, is ice container in position (see page 10)?
- Models 532, 542 and 561, is icemaker switch turned on (see page 10)?
- Model 590, is icemaker switch turned on (see page 12)?

If there is odor in the unit —

- Completely clean product (see pages 13 and 14).
- Cover all food tightly.

If light bulb needs replacing —

▲WARNING

- Turn off circuit breaker to refrigerator, wear gloves to protect against broken glass (see pages 15 and 16).

If you hear occasional buzzing —

- Is water supply connected to icemaker and turned on?

If you need product information —

- Please call 1-800-222-7820 for information on planning, installation or product knowledge.

If you need product service —

- Please have model and serial number available (for model and serial numbers refer to plate located on top frame of unit inside door.)
- Call your nearest Sub-Zero Factory Authorized Service Center. For the location of a Sub-Zero Factory Authorized Service Center in your area, contact your dealer or: Sub-Zero Freezer Co., Inc., Service Department, P.O. Box 44130, Madison, WI 53744-4130, Telephone 1-800-222-7820.

